

The high-performance concrete screw for absolute installation ease

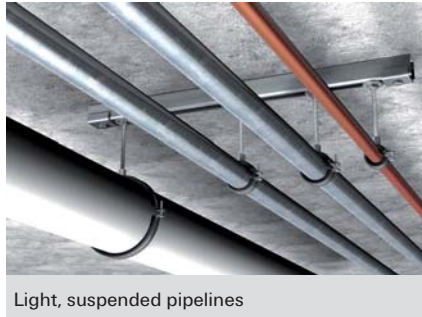

Light, suspended pipelines



Suspended air-conditioners

VERSIONS

- Zinc-plated steel

BUILDING MATERIALS

Approved for:

- Concrete C20/25 to C50/60, cracked and non-cracked
- Prestressed hollow concrete ceilings C30/37 to C50/60 for the multiple use of non-load bearing systems

Also suitable for:

- Concrete C12/15
- Solid building materials
- Masonry with dense structure

CERTIFICATES

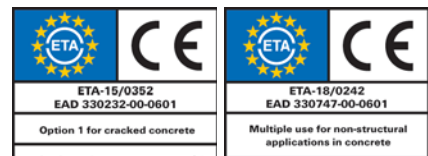

ADVANTAGES

- The first concrete screw with diameter 6 with variable embedment depth offers a flexible adaption of the embedment depth to the loads.
- The ETA assessment option 1 includes the use in cracked and non-cracked concrete for highest safety requirements.
- The first 6 mm diameter concrete screw with an ETA assessment for the C1 seismic performance category for additional safety standards.
- Different head designs offer a maximum of flexibility and a perfect adaptation to the application.
- The ULTRACUT FBS II 6 is approved for multiple use of non-load bearing systems and thereby ideal for the installation of pipe routes, cable trays and prestressed hollow concrete ceilings.

APPLICATIONS

- Pipeline routes
- Suspension for individual pipes
- Suspended mounting rails
- Prestressed concrete hollow core ceilings
- Cable trays
- Ventilation ducts
- Perforated tapes
- Air conditioning units

FUNCTIONING

- The ULTRACUT FBS II is recommended for the push-through / pre-positioned installation.
- Drill holes do not need to be cleaned during vertical installation (ceiling and floor). For floor fixings the hole must be drilled 3x drill hole diameter deeper.
- The approved adjustment for the concrete screws allows the screw to be unscrewed twice for a total length of 20 mm, to place maximum 10 mm packing below the base plates or to align the attached part, and then to tighten the screw again.
- We recommend using a tangential impact screwdriver with a suitable impact screwdriver socket or an internal torx drive.
- The screw is installed correctly when the screw head sits flush on the fixture (visual setting control).



Elite Fasteners

Specialist Distributors To The Construction Industry

INSTALLATION

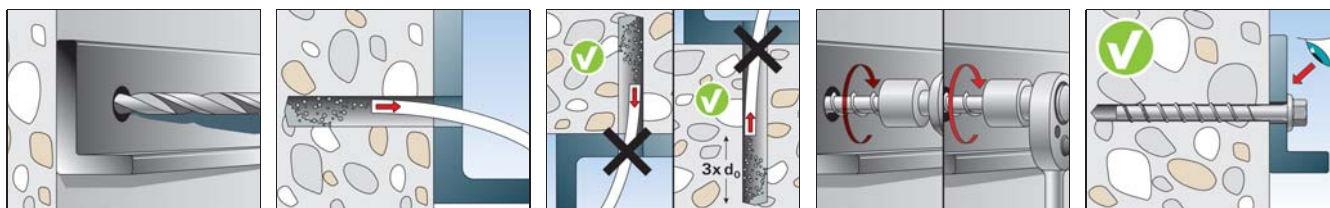

FIXTURE ADJUSTMENT

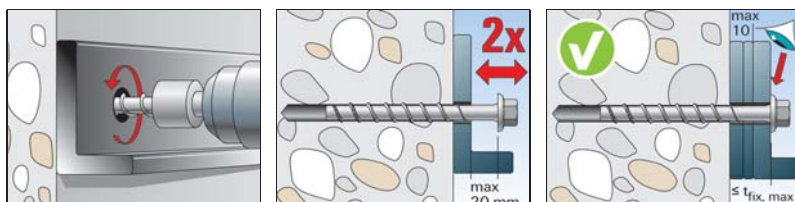

ADDITIONAL FOR SEISMIC

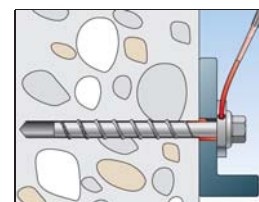

TECHNICAL DATA



ULTRACUT FBS II 6 P - panhead



ULTRACUT FBS II 6 SK - countersunk



ULTRACUT FBS II 6 US - hexagon head with molded washer

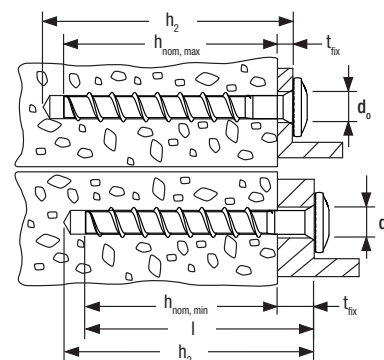

Item	Art.-No.	Approval ETA	Drill hole diameter	Min. drill hole depth for through fixings	Screw length	Head-Ø	Screw-in depth	Usable length	Drive	Sales unit
			d_0 [mm]	h_2 [mm]	l_s [mm]	d_K [mm]	$h_{nom,min}$ - $h_{nom,max}$ [mm]	$t_{fix,min}$ - $t_{fix,max}$ [mm]		
FBS II 6 x 30/5 P	546377	■	6	40	30	14.4	25	Screw length - h_{nom}	T30	100
FBS II 6 x 40/5 P	546378	■	6	50	40	14.4	25 - 35	Screw length - h_{nom}	T30	100
FBS II 6 x 40/5 LP	546379	■	6	50	40	17.5	25 - 35	Screw length - h_{nom}	T30	100
FBS II 6 x 60/5 P	546380	■	6	70	60	14.4	25 - 55	Screw length - h_{nom}	T30	100
FBS II 6 x 80/25 P	546381	■	6	90	80	14.4	25 - 55	Screw length - h_{nom}	T30	100
FBS II 6 x 30/5 SK	546382	■	6	40	30	13.5	25	Screw length - h_{nom}	T30	100
FBS II 6 x 40/5 SK	546383	■	6	50	40	13.5	25 - 35	Screw length - h_{nom}	T30	100
FBS II 6 x 60/5 SK	546384	■	6	70	60	13.5	25 - 55	Screw length - h_{nom}	T30	100
FBS II 6 x 80/25 SK	546385	■	6	90	80	13.5	25 - 55	Screw length - h_{nom}	T30	100
FBS II 6 x 100/45 SK	546386	■	6	110	100	13.5	25 - 55	Screw length - h_{nom}	T30	100
FBS II 6 x 120/65 SK	546387	■	6	130	120	13.5	25 - 55	Screw length - h_{nom}	T30	100
FBS II 6 x 140/85 SK	546388	■	6	150	140	13.5	25 - 55	Screw length - h_{nom}	T30	100
FBS II 6 x 160/105 SK	546389	■	6	170	160	13.5	25 - 55	Screw length - h_{nom}	T30	100
FBS II 6 x 40/5 US	546390	■	6	50	40	17	25 - 35	Screw length - h_{nom}	SW 10	100
FBS II 6 x 60/5 US	546391	■	6	70	60	17	25 - 55	Screw length - h_{nom}	SW 10	100
FBS II 6 x 80/25 US	546392	■	6	90	80	17	25 - 55	Screw length - h_{nom}	SW 10	100
FBS II 6 x 100/45 US	546393	■	6	110	100	17	25 - 55	Screw length - h_{nom}	SW 10	100
FBS II 6 x 120/65 US	546394	■	6	130	120	17	25 - 55	Screw length - h_{nom}	SW 10	100

TECHNICAL DATA



ULTRACUT FBS II M8/M10
- outside diameter



ULTRACUT FBS II M8/M10 I
- internal thread M8/M10

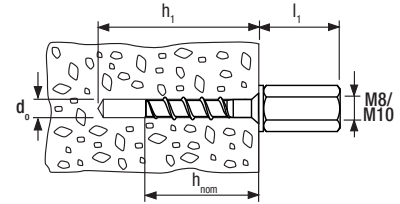

Item	Art.-No.	Approval ETA	Drill hole diameter	Min. drill hole depth for pre-positioned installation	Projection length	Screw-in depth	Drive	Sales unit [pcs]	
			d_0 [mm]	h_1 [mm]	l_1 [mm]	h_{nom} [mm]			
FBS II 6 x 25 M8/19	546395	■	6	35	19	25	SW 10	100	
FBS II 6 x 35 M8/19	546396	■	6	45	19	35	SW 10	100	
FBS II 6 x 55 M8/19	546397	■	6	65	19	55	SW 10	100	
FBS II 6 x 35 M10/21	546398	■	6	45	21	35	SW 13	100	
FBS II 6 x 55 M10/21	546399	■	6	65	21	55	SW 13	100	
FBS II 6 x 35 M8/M10 I	546400	■	6	45	37	35	SW 13	100	
FBS II 6 x 55 M8/M10 I	546401	■	6	65	37	55	SW 13	100	

LOADS

Concrete screw ULTRACUT FBS II 6

zinc plated steel

Permissible loads of a single anchor in cracked normal concrete (concrete tension zone) of strength class C20/25 (~B25) ^{1) 2) 3) 10)}											Minimum spacings while reducing the load	
Type	Material fixing element	Minimum member thickness	Screw-in depth	Maximum installation torque	Installation torque	Permissible tensile load	Permissible shear load	Required edge distance (with one edge) for		Required spacing for	Min. spacing	Min. edge distance
								Max. tension load	Max. shear load			
		h_{min} [mm]	h_{nom} [mm]	T_{max} [Nm]	$T_{imp,max}^{6)}$ [Nm]	$N_{perm}^{7)}$ [kN]	$V_{perm}^{7)}$ [kN]	c	c	s_{cr} [mm]	$s_{min}^{8)}$ [mm]	$c_{min}^{8)}$ [mm]
FBS II 6x40⁵⁾	gvz	80	40	10	450	1,2	4,3	35	110	100	35	35
FBS II 6x45⁵⁾	gvz	90	45	10	450	1,7	4,3	35	105	110	35	35
FBS II 6x50⁵⁾	gvz	90	50	10	450	1,9	4,3	35	100	120	35	35
FBS II 6x55⁵⁾	gvz	100	55	10	450	2,4	6,3	35	145	135	35	35

For the design the complete assessment ETA-15/0352 has to be considered.⁹⁾

¹⁾ The partial safety factors for material resistance as regulated in the ETA-15/0352 as well as a partial safety factor for load actions of $\gamma_L = 1,4$ are considered. As an single anchor counts e.g. an anchor with a spacing $s \geq 3 \cdot h_{ef}$ and an edge distance $c \geq 1,5 \cdot h_{ef}$. Accurate data see ETA-15/0352.

²⁾ For higher concrete strength classes up to C50/60 higher permissible loads may be possible.

³⁾ Drill method hammer drilling resp. hollow drilling. For further allowable drill methods see ETA-15/0352.

⁴⁾ The anchorage depths smaller than 40 mm are only allowed for single anchors as part of a multiple fixing of non-structural systems.

⁵⁾ Diamond drilling not permitted.

⁶⁾ Maximum allowable torque for installation with any tangential impact screw driver.

⁷⁾ For combinations of tensile loads and shear loads or for shear loads with lever arm (bending moments) as well as reduced edge distances or spacings (anchor groups) we recommend to use our anchor design software C-FIX.

⁸⁾ Minimum possible axial spacings resp. edge distance while reducing the permissible load.

⁹⁾ The given loads refer to the European Technical Assessment ETA-15/0352, issue date 30/10/2018. Design of the loads according ETAG 001, Annex C, Method A (for static resp. quasi-static loads).

¹⁰⁾ A reinforcement in the concrete to prevent splitting is required. The width of the cracks has to be limited under consideration of the splitting forces at $w_k \sim 0,3$ mm.

LOADS

Concrete screw ULTRACUT FBS II 6

zinc plated steel

Permissible loads of a single anchor in non-cracked normal concrete (concrete compression zone) of strength class C20/25 (~B25) ¹⁾²⁾³⁾											Minimum spacings while reducing the load	
Type	Material fixing element	Minimum member thickness	Screw-in depth	Maximum installation torque	Installation torque	Permissible tensile load	Permissible shear load	Required edge distance (with one edge) for		Required spacing for	Min. spacing	Min. edge distance
		h_{min} [mm]	h_{nom} [mm]	T_{max} [Nm]	T_{imp,max_6} [Nm]	$N_{perm}^{7)}$ [kN]	$V_{perm}^{7)}$ [kN]	Max. tension load c [mm]	Max. shear load c [mm]	Max. Load s_{cr} [mm]	$s_{min}^{8)}$ [mm]	$c_{min}^{8)}$ [mm]
FBS II 6x40 ⁵⁾	gvz	80	40	10	450	3,8	4,3	40	75	100	35	35
FBS II 6x45 ⁵⁾	gvz	90	45	10	450	4,8	4,3	50	70	110	35	35
FBS II 6x50 ⁵⁾	gvz	90	50	10	450	5,7	4,3	55	70	120	35	35
FBS II 6x55 ⁵⁾	gvz	100	55	10	450	6,4	6,3	60	100	135	35	35

For the design the complete assessment ETA-15/0352 has to be considered.⁹⁾

¹⁾ The partial safety factors for material resistance as regulated in the ETA-15/0352 as well as a partial safety factor for load actions of $\gamma_L = 1,4$ are considered. As a single anchor counts e.g. an anchor with a spacing $s \geq 3 \cdot h_{ef}$ and an edge distance $c \geq 1,5 \cdot h_{ef}$. Accurate data see ETA-15/0352.

²⁾ For higher concrete strength classes up to C50/60 higher permissible loads may be possible.

³⁾ Drill method hammer drilling resp. hollow drilling. For further allowable drill methods see ETA-15/0352.

⁴⁾ The anchorage depths smaller than 40 mm are only allowed for single anchors as part of a multiple fixing of non-structural systems.

⁵⁾ Diamond drilling not permitted.

⁶⁾ Maximum allowable torque for installation with any tangential impact screw driver.

⁷⁾ For combinations of tensile loads and shear loads or for shear loads with lever arm (bending moments) as well as reduced edge distances or spacings (anchor groups) we recommend to use our anchor design software C-FIX.

⁸⁾ Minimum possible axial spacings resp. edge distance while reducing the permissible load.

⁹⁾ The given loads refer to the European Technical Assessment ETA-15/0352, issue date 30/10/2018. Design of the loads according ETAG 001, Annex C, Method A (for static resp. quasi-static loads).

LOADS

Concrete screw ULTRACUT FBS II 6 zinc plated

Highest permissible loads for a single anchor¹⁾ for multiple use for non-structural applications in cracked concrete C20/25 to C50/60.

Type	Material fixing element	Screw-in depth	Min. member thickness	Installation torque	Permissible tensile load	Permissible shear load	Required edge distance (with one edge) for		Required spacing for	Min. spacing	Min. edge distance
		h_{nom} [mm]	h_{min} [mm]	$T_{inst,max}$ [Nm]	$N_{perm}^{3)}$ [kN]	$V_{perm}^{3)}$ [kN]	Max. tension load c [mm]	Max. shear load c [mm]	s [mm]	$s_{min}^{2)}$ [mm]	$c_{min}^{2)}$ [mm]
FBS II 6	gvz	25	80	≤ 5	0.7	1.8	35	50	60	35	35
FBS II 6	gvz	30	80	≤ 5	1.2	3.0 ⁴⁾	35	55	70	35	35
FBS II 6	gvz	35	80	≤ 5	1.7	3.0 ⁴⁾	35	100	100	35	35
FBS II 6	gvz	40	80	≤ 10	2.4	3.0 ⁴⁾	35	105	110	35	35
FBS II 6	gvz	45	90	≤ 10	2.9	3.0 ⁴⁾	40	110	115	35	35
FBS II 6	gvz	50	90	≤ 10	3.0 ⁴⁾	3.0 ⁴⁾	50	115	120	35	35
FBS II 6	gvz	55	100	≤ 10	3.0 ⁴⁾	3.0 ⁴⁾	50	145	135	35	35

For the design the complete assessment ETA-18/0242, issued 30.10.2018 has to be considered.

¹⁾ The partial safety factors for material resistance as regulated in the approval as well as a partial safety factor for load actions of $\gamma_L = 1,4$ are considered. As a single anchor counts e.g. an anchor with a spacing $s \geq 3 \times h_{ef}$ and an edge distance $c \geq 1,5 \times h_{ef}$. Accurate data see assessment.

²⁾ Minimum possible axial spacings resp. edge distance while reducing the permissible load.

³⁾ For combinations of tensile loads, shear loads, bending moments as well as reduced edge distances or spacings (anchor groups) see assessment.

⁴⁾ The Resistance is covered by the CEN/TR 17079:2018 if no other national regulations exist.



Elite Fasteners

Specialist Distributors To The Construction Industry

LOADS

Concrete screw ULTRACUT FBS II 6 zinc plated

Highest permissible loads¹⁾ for a single anchor for multiple use for non-structural applications in pre-stressed hollow core slabs⁴⁾

Type		FBS II 6						
Nominal embedment depth	h_{nom}	25	30	35	40	45	50	55
Permissible load in the respective bottom flange thickness F_{rec}³⁾								
≥ 25 mm	[kN]	0,23	0,47	0,47	0,47	0,47	0,47	0,47
≥ 30 mm	[kN]	1,64	1,64	1,64	1,64	1,64	1,64	1,64
≥ 35 mm	[kN]	1,64	1,88	2,11	2,35	2,58	2,82	3,0 ⁴⁾
≥ 40 mm	[kN]	1,64	2,35	2,58	2,82	3,0 ⁴⁾	3,0 ⁴⁾	3,0 ⁴⁾
≥ 50 mm	[kN]	1,64	2,58	3,0 ⁴⁾	3,0 ⁴⁾	3,0 ⁴⁾	3,0 ⁴⁾	3,0 ⁴⁾
Installation torque	$T_{inst, max}$	[Nm]	5	5	10	10	10	10
Min. spacing	$s1, s2^{2)}$	[mm]	100	100	100	100	100	100
Min. edge distance	$c1, c2^{2)}$	[mm]	100	100	100	100	100	100

For the design the complete assessment ETA-18/0242, issued 30.10.2018 has to be considered.

1) The required partial safety factors for material resistance as well as a partial safety factor for load actions of $\gamma_L = 1,4$ are considered.

2) Minimum possible axial spacings resp. edge distance. For further measures see assessment.

3) Valid for tensile load, shear load and oblique load under any angle.

4) Concrete strength class C30/37 up to C50/60.

5) The Resistance is covered by the CEN/TR 17079:2018 if no other national regulations exist.

Additional assortment



Nut SW



FMB T40 Maxx Bit

Complement for ULTRACUT FBS II

Item	Art.-No.	Internal-Ø [mm]	External-Ø [mm]	Drive	Suitable for ULTRACUT FBS II [SW/TX]	Sales unit [pcs]
Nut SW 10	538577	-	-	1/2" / SW 10	FBS II 6	1
Nut SW 13	538578	-	-	1/2" / SW 13	FBS II 6 / FBS II 8	1
FMB T30 Maxx Bit W5	533158	-	-	TX 30	FBS II 6	50

From TR 17079

Table 4.1 — Recommended values for $F_{Ed,lim}$, n_1 and n_2

number of fixing points n_1	number of fasteners per fixing point n_2	limiting design action $F_{Ed,lim}$
≥ 4	≥ 1	3,0 kN
3	≥ 1	2,0 kN

NOTE The values for $F_{Ed,lim}$, n_1 and n_2 for use in a Country may be found in its National Annex.

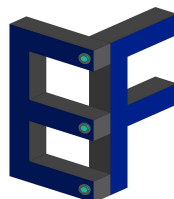

Elite Fasteners

Specialist Distributors To The Construction Industry